



- EFFICIENT ●
- ENERGY-SAVING ●
- ENVIRONMENTAL ●



NINGBO ZHENGNING LIGHTING TECHNOLOGY CO.,LTD.
 Add:No.258,Rixian Road,Cidong Industrial Park,Cixi Ningbo,Zhejiang,China
 Te1:+86-574-63785978
 Fax:+86-574-63983885
 E-mail:zn @znjd.com
 Http://www.zn-lighting.com

宁波市正宁照明科技有限公司
 NINGBO ZHENGNING LIGHTING TECHNOLOGY CO..LTD.

Brief Introduction

Founded in 2004, Ningbo Zhengning Lighting Technology Co., Ltd is located in Cidong industrial park, Cixi city, Zhejiang province, covering an area of 20,000 square meters. Being 40 kilometers to the west of the famous Ningbo port, in the face of Hangzhou Bay Sea-Crossing Bridge on the north and only 100 kilometers away from Shanghai, the company has an advantageous geographical location and convenient transportation. Since its inception, the company has been pouring new energy into itself depending on the scientific management concept of "credit from sincerity, business from quality and people first". The company has first-class scientific manpower as well as the advanced research facilities, automatic production facilities and detection facilities from home and abroad. The company continuously launches fashionable-style, energy-efficient and environmental, and practical

Qualification of company



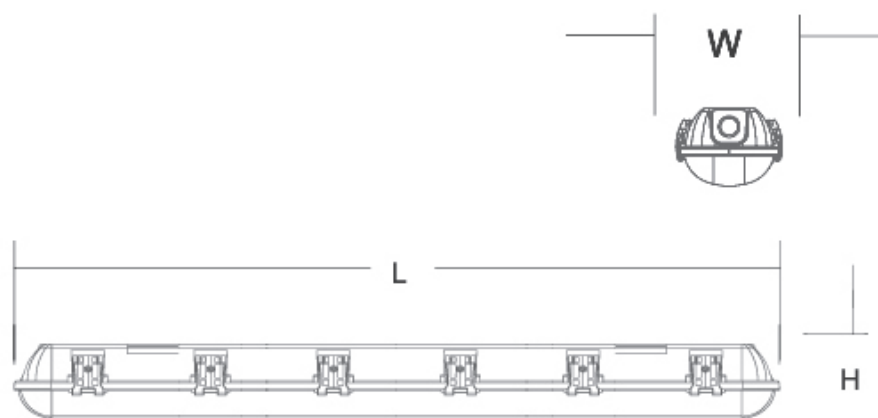

Model No. 型号	Material 材质	Input Voltage(V) 输入电压	Frenquency (Hz) 频率	CCT(K) 色温	Lm/W 光效	System Power(W). 整灯功率	Operating temp range. (°C) 可操作温度范围	Product Size(mm) 产品尺寸	Carton Size(mm) 外箱尺寸	Qty/CTN (pcs) 数量/箱
ZNSF060A	PC+PC	100-240VAC	50/60HZ	3000K -6500K	100-150	12/18/24/28	-30 ~ +40	660x100x75	625x320x250	9
ZNSF120A	PC+PC	100-240VAC	50/60HZ	3000K -6500K	100-150	36/40/54	-30 ~ +40	1260x100x75	1225x320x250	9
ZNSF150A	PC+PC	100-240VAC	50/60HZ	3000K -6500K	100-150	36/48/54/70	-30 ~ +40	1560x100x75	1525x320x250	9

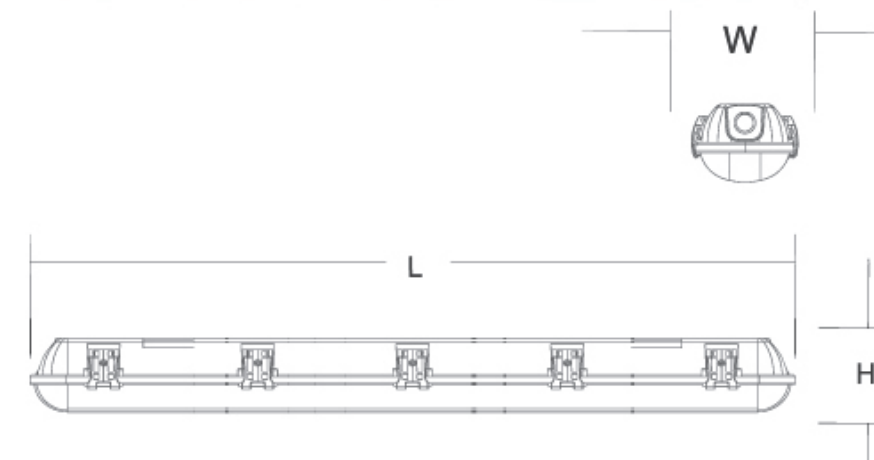

Model No. 型号	Material 材质	Input Voltage(V) 输入电压	LED Tube LED 灯管	Product Size(mm) 产品尺寸	Carton Size(mm) 外箱尺寸	Qty/CTN (pcs) 数量/箱
ZNSF106B	PC+PC	100-240VAC	1*0.6m	660x73x75	690x250x240	9
ZNSF112B	PC+PC	100-240VAC	1*1.2m	1260x73x75	1290x250x240	9
ZNSF115B	PC+PC	100-240VAC	1*1.5m	1560x73x75	1590x250x240	9
ZNSF206B	PC+PC	100-240VAC	2*0.6m	660x101x75	690x250x220	6
ZNSF212B	PC+PC	100-240VAC	2*1.2m	1260x101x75	1290x250x220	6
ZNSF215B	PC+PC	100-240VAC	2*1.5m	1560x101x75	1590x250x220	6

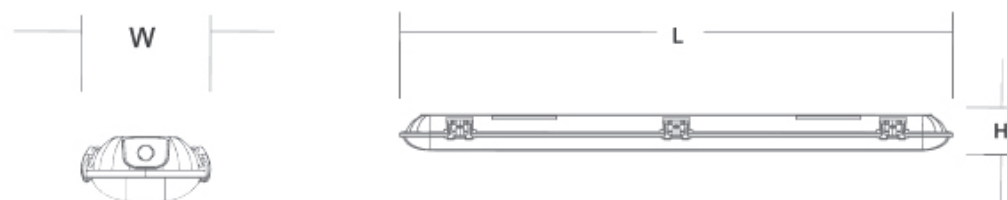

Model No. 型号	Material 材质	Input Voltage(V) 输入电压	LED Tube LED 灯管	Product Size(mm) 产品尺寸	Carton Size(mm) 外箱尺寸	Qty/CTN(pcs) 数量 / 箱
ZNSF106C	PC+PC	100-240VAC	1*0.6m	690x73x52	730x250x240	12
ZNSF112C	PC+PC	100-240VAC	1*1.2m	1290x73x52	1330x250x240	12
ZNSF115C	PC+PC	100-240VAC	1*1.5m	1590x73x52	1630x250x240	12
ZNSF206C	PC+PC	100-240VAC	2*0.6m	690x113x52	730x250x240	8
ZNSF212C	PC+PC	100-240VAC	2*1.2m	1290x113x52	1330x250x240	8
ZNSF215C	PC+PC	100-240VAC	2*1.5m	1590x113x52	1630x250x240	8

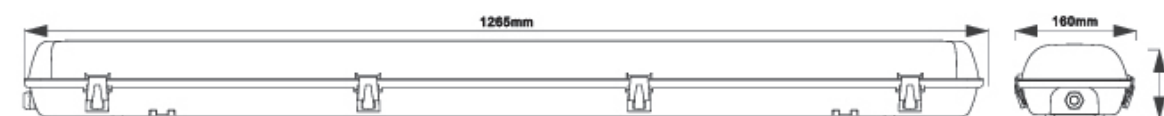

Model No. 型号	Material 材质	Input Voltage(V) 输入电压	Frequency (Hz) 频率	CCT(K) 色温	Lm/W 光效	System Power(W) 整灯功率	Operating temp range. (°C) 可操作温度范围	Product Size(mm) 产品尺寸	Carton Size(mm) 外箱尺寸	Qty/ CTN(pcs) 数量 / 箱
ZNSF120D	PC+PC	100-240VAC	50/60HZ	3000K -6500K	100-150	60/80	-30 ~ +40	1265x160x100	1275x335x330	6

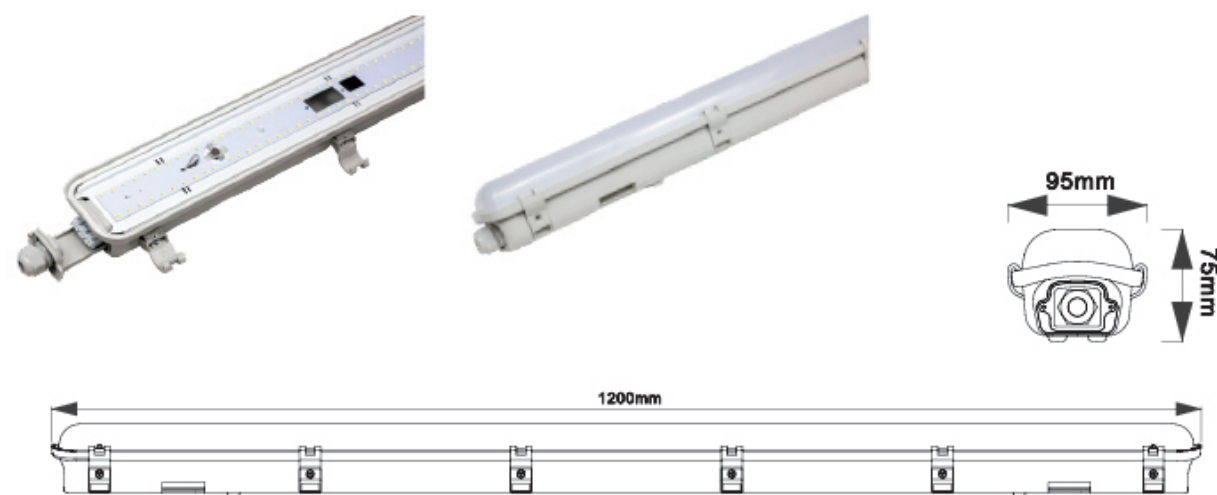
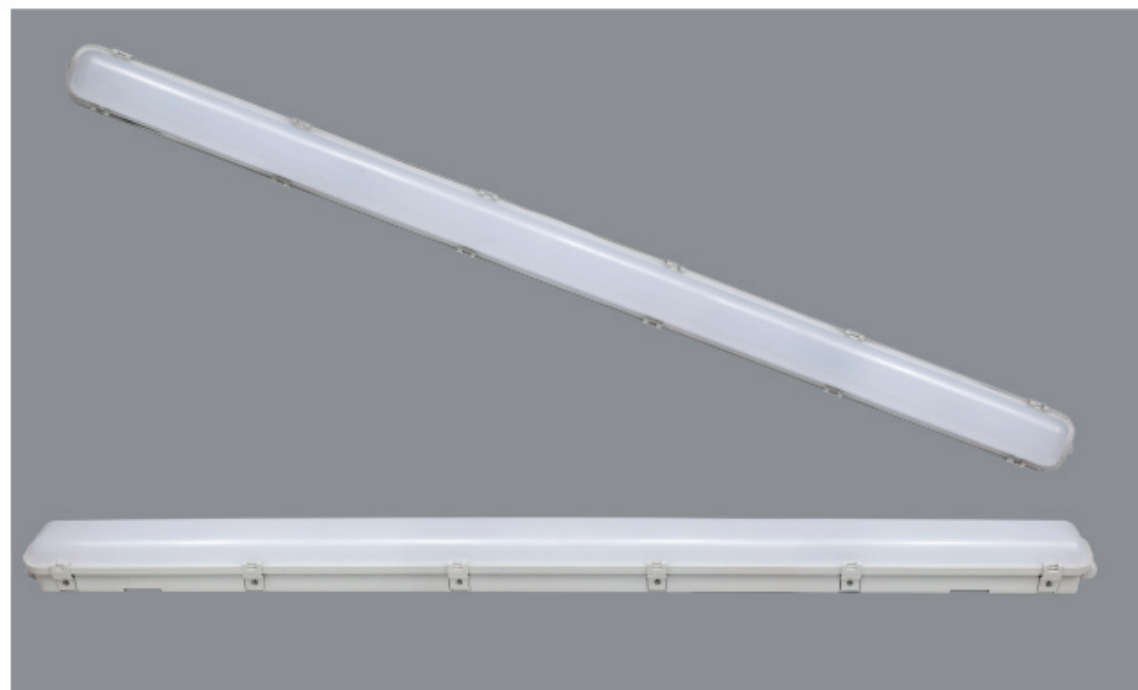

Model No. 型号	Material 材质	Input Voltage(V) 输入电压	Frequency (Hz) 频率	CCT(K) 色温	Lm/W 光效	System Power(W). 整灯功率	Operating temp range. (°C) 可操作温度范围	Product Size(mm) 产品尺寸	Carton Size(mm) 外箱尺寸	Qty/ CTN(pcs) 数量 / 箱
ZNSF120E	PC+PC	100-240VAC	50/60HZ	3000K -6500K	100-150	36/48	-30 ~ +40	1200x95x75	1215x310x255	9

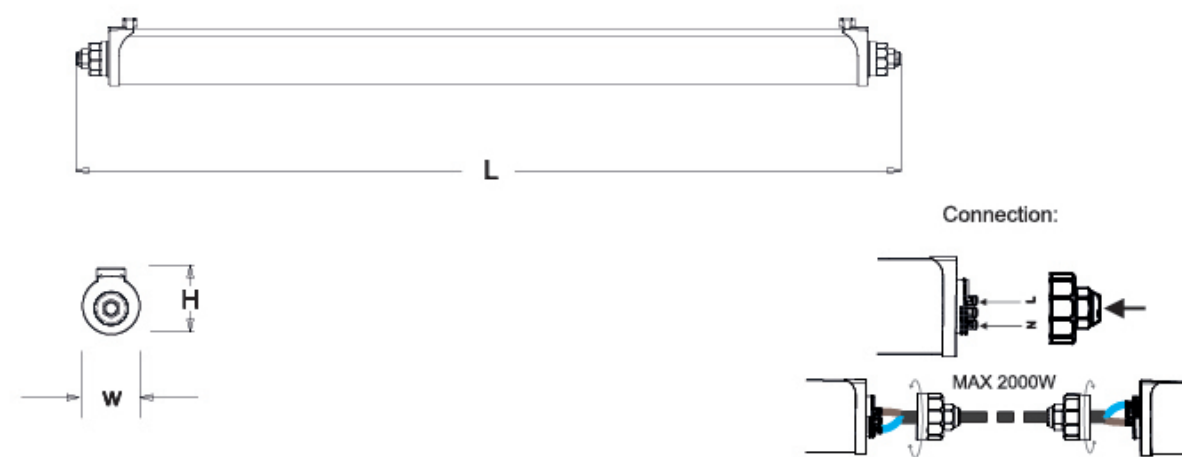

Model No. 型号	Material 材质	Input Voltage(V) 输入电压	Frequency (Hz) 频率	CCT(K) 色温	Lm/W 光效	System Power(W). 整灯功率	Operating temp range. (°C) 可操作温度范围	Product Size(mm) 产品尺寸	Carton Size (mm) 外箱尺寸	Qty/CTN (pcs) 数量 / 箱
ZNSF600F	PC+PC	100-240VAC	50/60HZ	3000K -6500K	100-150	20	-30 ~ +40	700x90x92	720x295x300	9
ZNSF1200F	PC+PC	100-240VAC	50/60HZ	3000K -6500K	100-150	40	-30 ~ +40	1300x90x92	1320x295x300	9
ZNSF1500F	PC+PC	100-240VAC	50/60HZ	3000K -6500K	100-150	60	-30 ~ +40	1500x90x92	1620x295x300	9

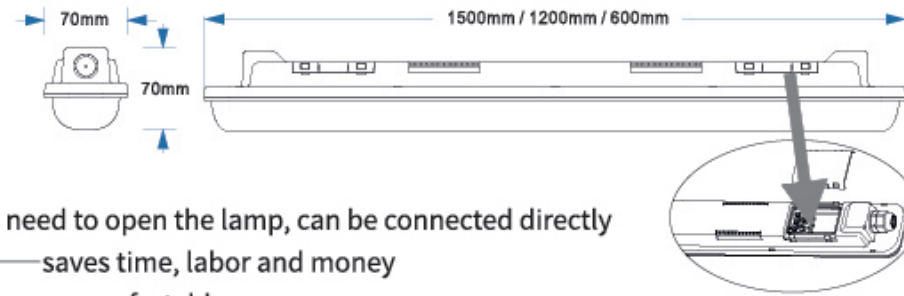
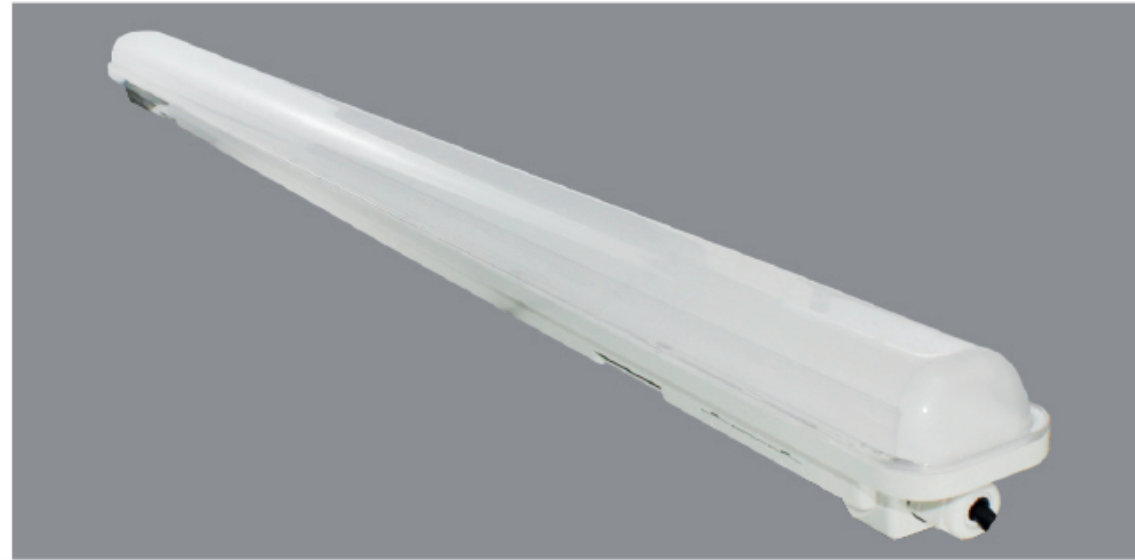

- 1: No click, no need to open the lamp, can be connected directly
- 2: Installation—saves time, labor and money
- 3: Non-flicker, more comfortable
- 4: Suitable for underground parking, shopping malls, corridors and other places.

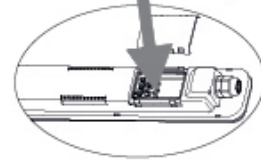

Model No. 型号	Material 材质	Input Voltage(V) 输入电压	Frequency (Hz) 频率	CCT(K) 色温	Lm/W 光效	System Power(W). 整灯功率	Operating temp range. (°C) 可操作温度范围	Product Size (mm) 产品尺寸	Carton Size(mm) 外箱尺寸	Qty/ CTN(pcs) 数量/箱
ZNSF600G	PC+PC	100-240VAC	50/60HZ	3000K-6500K	100-150	18	-30 ~ +40	600x70x70	620x230x235	9
ZNSF1200G	PC+PC	100-240VAC	50/60HZ	3000K-6500K	100-150	36/48	-30 ~ +40	1200x70x70	1220x230x235	9
ZNSF1500G	PC+PC	100-240VAC	50/60HZ	3000K-6500K	100-150	48	-30 ~ +40	1500x70x70	1520x230x235	9

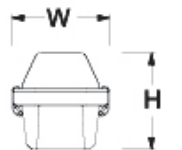
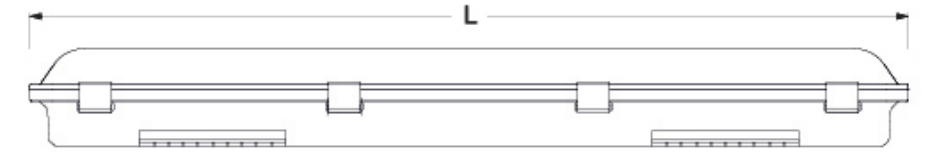

- 1: More lightweight design, more economic.
- 2: Installation—saves time, labor and money
- 3: Non-flicker, more comfortable
- 4: Suitable for underground parking, shopping malls, corridors and other places.

Model No. 型号	Material 材质	Input Voltage(V) 输入电压	Frequency (Hz) 频率	CCT(K) 色温	Lm/W 光效	System Power(W). 整灯功率	Operating temp range. (°C) 可操作温度范围	Product Size (mm) 产品尺寸	Carton Size(mm) 外箱尺寸	Qty/CTN (pcs) 数量/箱
ZNSF600H	PC+PC	100-240VAC	50/60HZ	3000K-6500K	100-150	18	-30 ~ +40	600x68x70	620x225x230	9
ZNSF1200H	PC+PC	100-240VAC	50/60HZ	3000K-6500K	100-150	36/48	-30 ~ +40	1200x68x70	1220x225x230	9
ZNSF1500H	PC+PC	100-240VAC	50/60HZ	3000K-6500K	100-150	48	-30 ~ +40	1500x68x70	1520x225x230	9

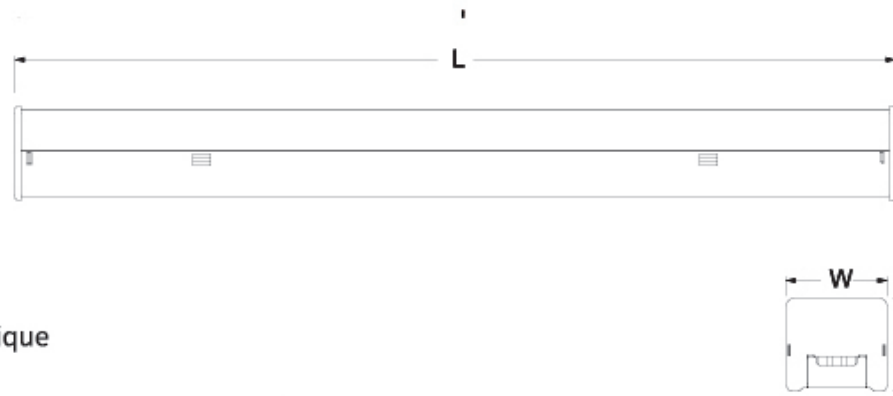
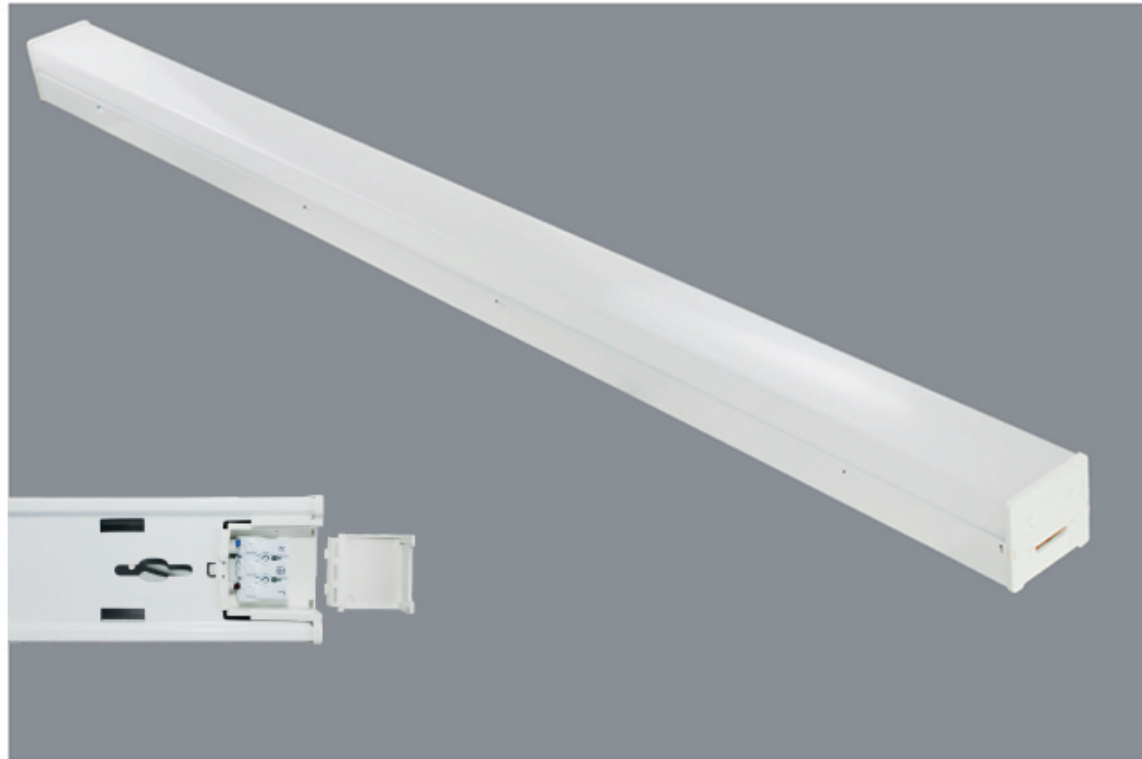

- 1: Novel design, unique
- 2: Non-flicker
- 3: Metal shell, good heat dissipation, more firm
- 4: Suitable for shopping malls, office areas and other places

Model No. 型号	Material 材质	Input Voltage(V) 输入电压	Frequency (Hz) 频率	CCT(K) 色温	Lm/W 光效	System Power(W). 整灯功率	Operating temp range. (°C) 可操作温度范围	Product Size(mm) 产品尺寸	Carton Size(mm) 外箱尺寸	Qty/ CTN(pcs) 数量 / 箱
ZNTP600J	PC+iron(铁)	100-240VAC	50/60HZ	3000K-6500K	100-150	18/22	-30 ~ +40	600x68x63	615x225x215	9
ZNTP1200J	PC+iron(铁)	100-240VAC	50/60HZ	3000K-6500K	100-150	30/48	-30 ~ +40	1200x68x63	1215x225x215	9
ZNTP1500J	PC+iron(铁)	100-240VAC	50/60HZ	3000K-6500K	100-150	50/60	-30 ~ +40	1500x68x63	1515x225x215	9

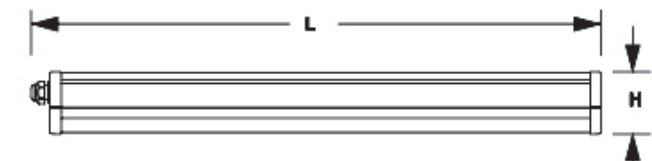
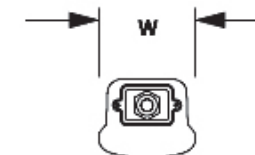

Model No. 型号	Material 材质	Input Voltage(V) 输入电压	Frequency (Hz) 频率	CCT(K) 色温	Lm/W 光效	System Power(W). 整灯功率	Operating temp range. (°C) 可操作温度范围	Product Size(mm) 产品尺寸	Carton Size(mm) 外箱尺寸	Qty/ CTN(pcs) 数量 / 箱
ZNSFL060	PC	100-240VAC	50/60HZ	3000K-6500K	100-150	18/24	-30 ~ +40	600x83x68	670x285x240	9
ZNSFL120	PC	100-240VAC	50/60HZ	3000K-6500K	100-150	36/44	-30 ~ +40	1200x83x68	1270x285x240	9
ZNSFL150	PC	100-240VAC	50/60HZ	3000K-6500K	100-150	48/54	-30 ~ +40	1500x83x68	1570x285x240	9

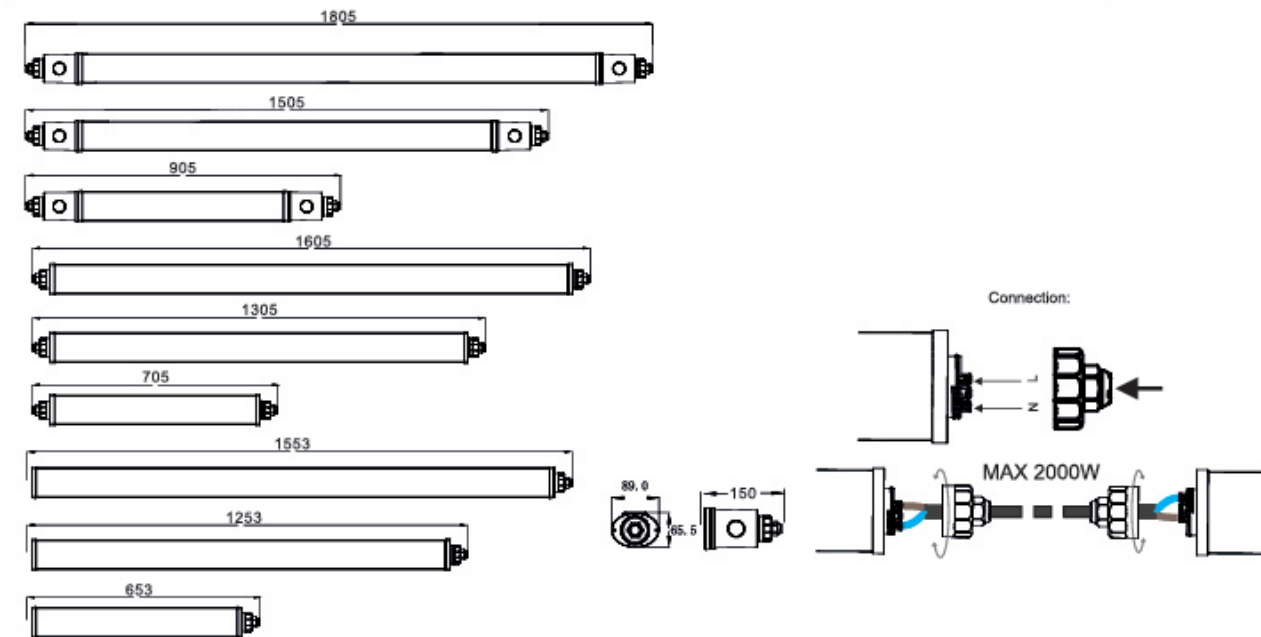

Model No. 型号	Material 材质	Input Voltage(V) 输入电压	Frequency (Hz) 频率	CCT(K) 色温	Lm/W 光效	System Power(W). 整灯功率	Operating temp range. (°C) 可操作温度范围	Product Size(mm) 产品尺寸	Carton Size(mm) 外箱尺寸	Qty/ CTN(pcs) 数量 / 箱
ZNSF600M	PC	100-240VAC	50/60HZ	3000K-6500K	100-150	18/24/28	-30 ~ +40	705x90x66	760x295x225	9
ZNSF1200M	PC	100-240VAC	50/60HZ	3000K-6500K	100-150	30/36/40	-30 ~ +40	1305x90x66	1360x295x225	9
ZNSF1500M	PC	100-240VAC	50/60HZ	3000K-6500K	100-150	45/50/60	-30 ~ +40	1605x90x66	1660x295x225	9

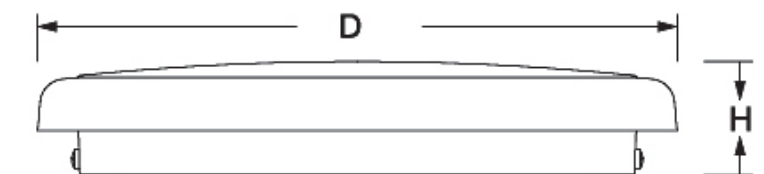

Model No. 型号	Material 材质	Input Voltage(V) 输入电压	Frequency (Hz) 频率	CCT(K) 色温	Lm/W 光效	System Power (W). 整灯功率	Operating temp range. (°C) 可操作温度范围	Product Size(mm) 产品尺寸	Carton Size(mm) 外箱尺寸	Qty/ CTN(pcs) 数量 / 箱
ZNXD0305L	PC	100-240VAC	50/60HZ	3000K-6500K	100-150	8-24	-30 ~ +40	Φ305x53	475x320x325	8

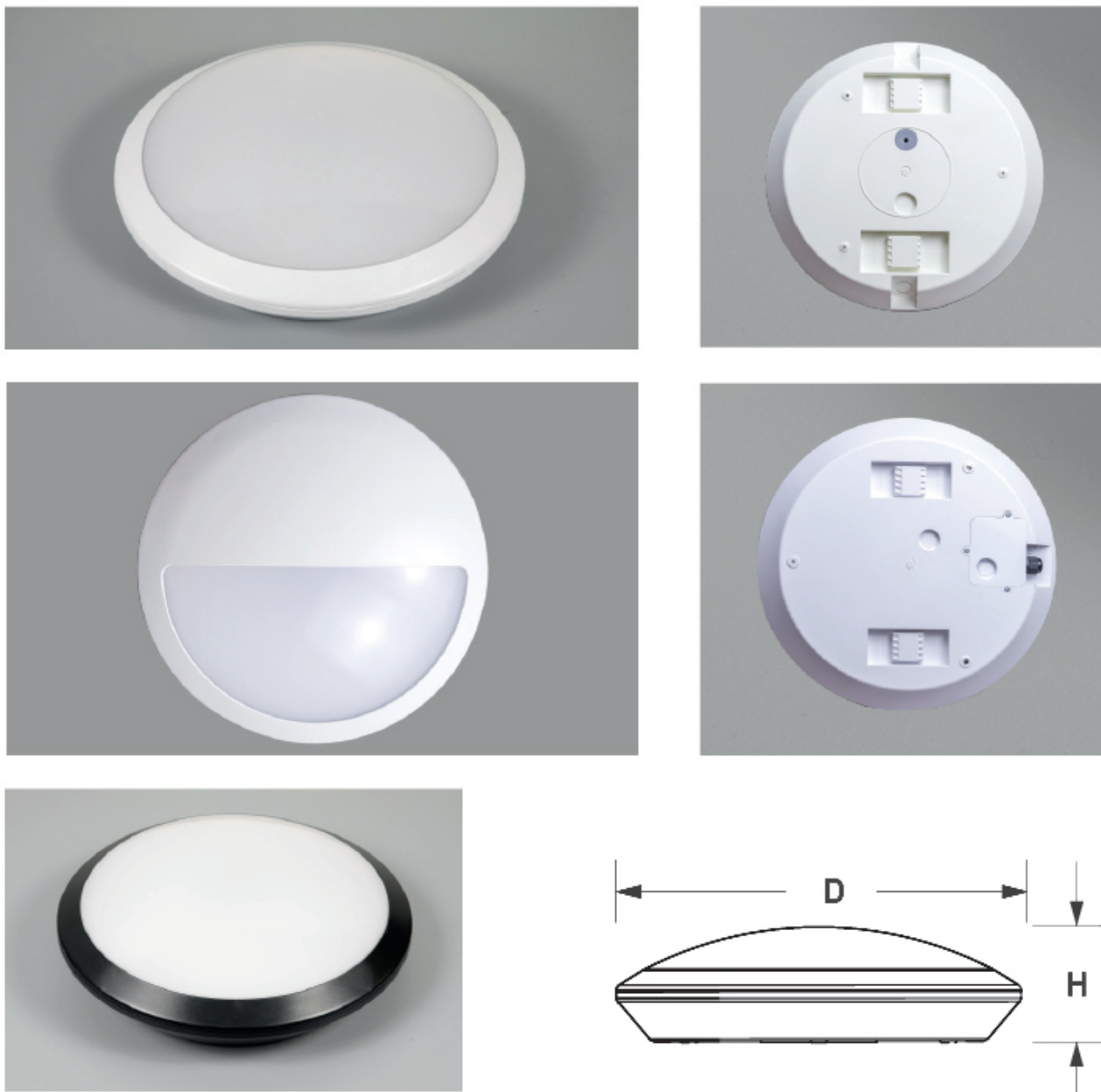

Model No. 型号	Material 材质	Input Voltage(V) 输入电压	Frequency (Hz) 频率	CCT(K) 色温	Lm/W 光效	System Power(W). 整灯功率	Operating temp range. (°C) 可操作温度范围	Product Size(mm) 产品尺寸	Carton Size(mm) 外箱尺寸	Qty/ CTN (pcs) 数量 / 箱
ZNXD0300D-N	PC	100-240VAC	50/60HZ	3000K-6500K	100-150	12/15/20	-30 ~ +40	Φ308x89	570x320x325	6
ZNXD0300DB-N	PC	100-240VAC	50/60HZ	3000K-6500K	100-150	12/15/20	-30 ~ +40	Φ308x89	570x320x325	6
ZNXD0300D-N1	PC	100-240VAC	50/60HZ	3000K-6500K	100-150	12/15/20	-30 ~ +40	Φ308x99	640x320x325	6
ZNXD0350D-N	PC	100-240VAC	50/60HZ	3000K-6500K	100-150	18/20/24	-30 ~ +40	Φ350x108	680x370x370	6
ZNXD0350D-N1	PC	100-240VAC	50/60HZ	3000K-6500K	100-150	18/20/24	-30 ~ +40	Φ350x108	680x370x370	6



Model No. 型号	Material 材质	Input Voltage(V) 输入电压	Frequency (Hz) 频率	CCT(K) 色温	Lm/W 光效	System Power(W). 整灯功率	Operating temp range. (°C) 可操作温度范围	Product Size(mm) 产品尺寸	Carton Size(mm) 外箱尺寸	Qty/ CTN (pcs) 数量 / 箱
ZNXD0290D-N	PC	100-240VAC	50/60HZ	3000K-6500K	100-150	12/15/20/24	-30 ~ +40	300x300x79	540x315x330	6



Light Sensor



With sufficient light, the lamp doesn't switch on.



With insufficient ambient light, the sensor switches on the lamp when motion is detected.

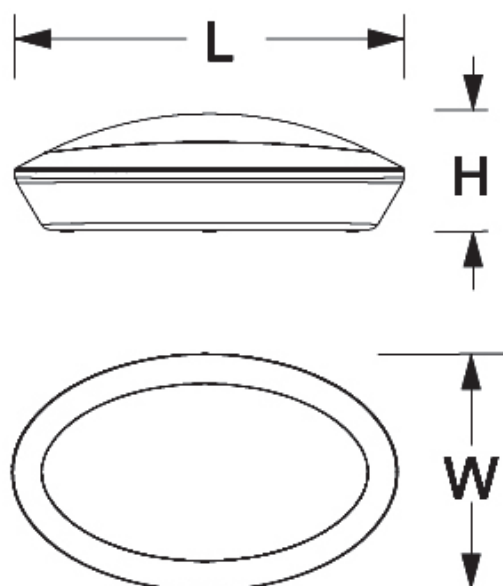

Model No. 型号	Material 材质	Input Voltage(V) 输入电压	Frequency (Hz) 频率	CCT(K) 色温	Lm/W 光效	System Power(W). 整灯功率	Operating temp range. (°C) 可操作温度范围	Product Size(mm) 产品尺寸	Carton Size(mm) 外箱尺寸	Qty/CTN 数量 / 箱
ZNXD0200DA-N	PC	100-240VAC	50/60HZ	3000K-6500K	100-150	9/12	-30 ~ +40	260x160x79	520x275x345	12
ZNXD0200DB-N	PC	100-240VAC	50/60HZ	3000K-6500K	100-150	6/9	-30 ~ +40	260x160x79	520x275x345	12



ZNXD0220M-10A

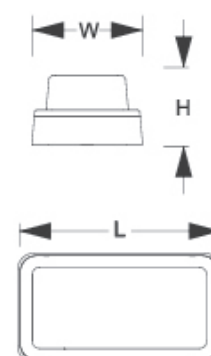

ZNXD0220M-10B

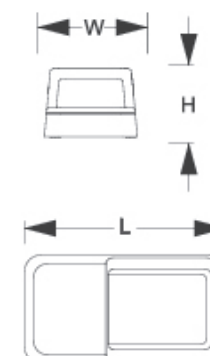

ZNXD0220M-10C



Light Sensor



With sufficient light, the lamp doesn't switch on.



With insufficient ambient light, the sensor switches on the lamp when motion is detected.

Model No. 型号	Material 材质	Input Voltage(V) 输入电压	Frequency (Hz) 频率	CCT(K) 色温	Lm/W 光效	System Power(W). 整灯功率	Operating temp range. (°C) 可操作温度范围	Product Size(mm) 产品尺寸	Carton Size(mm) 外箱尺寸	Qty/ CTN(pcs) 数量 / 箱
ZNXD0220M-A	PC	100-240VAC	50/60HZ	3000K-6500K	100-150	10	-30 ~ +40	220x120x75	490x240x260	12
ZNXD0220M-B	PC	100-240VAC	50/60HZ	3000K-6500K	100-150	10	-30 ~ +40	220x120x88	565x240x260	12
ZNXD0220M-C	PC	100-240VAC	50/60HZ	3000K-6500K	100-150	10	-30 ~ +40	220x120x88	565x240x260	12



Model No. 型号	Material 材质	Input Voltage(V) 输入电压	Frequency (Hz) 频率	CCT(K) 色温	Lm/W 光效	System Power(W). 整灯功率	Operating temp range. (°C) 可操作温度范围	Product Size(mm) 产品尺寸	Carton Size(mm) 外箱尺寸	Qty/ CTN(pcs) 数量/箱
ZNXD0300B	PC	100-240VAC	50/60HZ	3000K -6500K	100-150	12/15	-30 ~ +40	Φ300x92	590x315x320	6



Model No. 型号	Material 材质	Input Voltage(V) 输入电压	Frequency (Hz) 频率	CCT(K) 色温	Lm/W 光效	System Power(W). 整灯功率	Operating temp range. (°C) 可操作温度范围	Product Size(mm) 产品尺寸	Carton Size(mm) 外箱尺寸	Qty/ CTN(pcs) 数量/箱
ZNXD0300F	PC	100-240VAC	50/60HZ	3000K -6500K	100-150	12/15	-30 ~ +40	Φ305x80	525x320x325	6
ZNXD0400F	PC	100-240VAC	50/60HZ	3000K -6500K	100-150	20/24/30	-30 ~ +40	Φ400x88	570x415x320	6

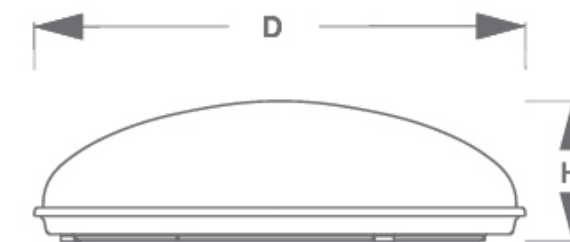
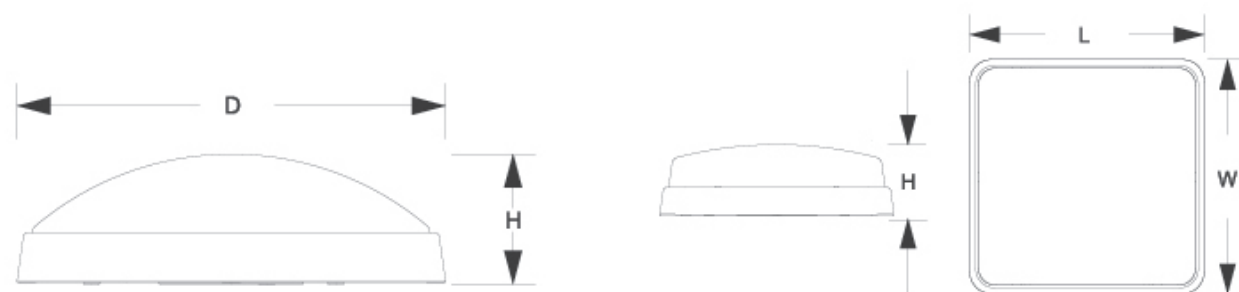
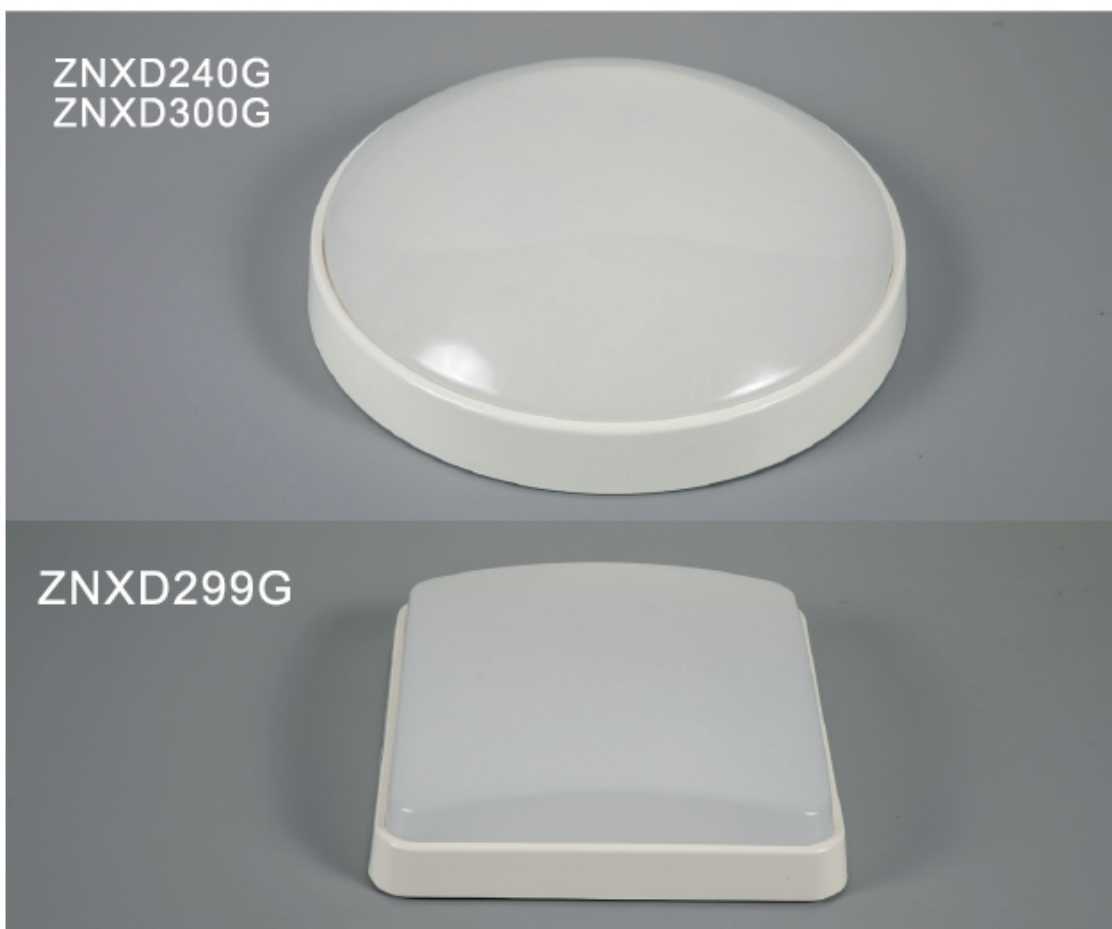

Model No. 型号	Material 材质	Input Voltage(V) 输入电压	Frequency (Hz) 频率	CCT(K) 色温	Lm/W 光效	System Power(W) 整灯功率	Operating temp range. (°C) 可操作温度范围	Product Size(mm) 产品尺寸	Carton Size(mm) 外箱尺寸	Qty/ CTN(pcs) 数量 / 箱
ZNXD 0240G	PC	100-240VAC	50/60HZ	3000K-6500K	100-150	8/12	-30 ~ +40	Φ240x75	490x255x260	6
ZNXD 0299G	PC	100-240VAC	50/60HZ	3000K-6500K	100-150	12/15	-30 ~ +40	299x299x91	585x315x320	6
ZNXD 0300G	PC	100-240VAC	50/60HZ	3000K-6500K	100-150	12/15	-30 ~ +40	Φ300x91	585x315x320	6

Model No. 型号	Material 材质	Input Voltage(V) 输入电压	Frequency (Hz) 频率	CCT(K) 色温	Lm/W 光效	System Power(W) 整灯功率	Operating temp range. (°C) 可操作温度范围	Product Size(mm) 产品尺寸	Carton Size(mm) 外箱尺寸	Qty/ CTN(pcs) 数量 / 箱
ZNXD0300H	PC	100-240VAC	50/60HZ	3000K-6500K	100-150	12/15	-30 ~ +40	Φ300x96	615x315x320	6
ZNXD0350H	PC	100-240VAC	50/60HZ	3000K-6500K	100-150	18/22	-30 ~ +40	Φ350x101	645x365x370	6



Model No. 型号	Material 材质	Input Voltage(V) 输入电压	Frequency (Hz) 频率	CCT(K) 色温	Lm/W 光效	System Power(W) 整灯功率	Operating temp range. (°C) 可操作温度范围	Product Size(mm) 产品尺寸	Carton Size(mm) 外箱尺寸	Qty/ CTN (pcs) 数量/箱
ZNXD0280K	PC	100-240VAC	50/60HZ	3000K-6500K	100-150	11/12/18	-30 ~ +40	Φ280x72	585x320x300	8

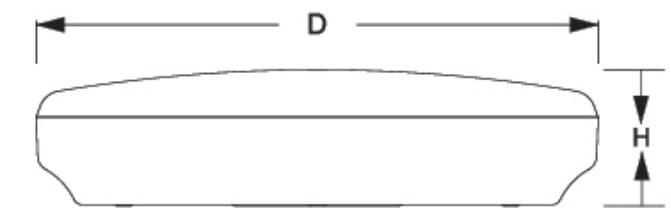

Model No. 型号	Material 材质	Input Voltage(V) 输入电压	Frequency (Hz) 频率	CCT(K) 色温	Lm/W 光效	System Power(W) 整灯功率	Operating temp range. (°C) 可操作温度范围	Product Size(mm) 产品尺寸	Carton Size(mm) 外箱尺寸	Qty/ CTN (pcs) 数量/箱
ZNXD 0350U1	PC	120VAC	50/60HZ	3000K-6500K	100-150	21	-30 ~ +40	Φ355x86	555x370x375	6
ZNXD 0350U2	PC	100-240VAC	50/60HZ	3000K-6500K	100-150	21	-30 ~ +40	Φ355x86	555x370x375	6

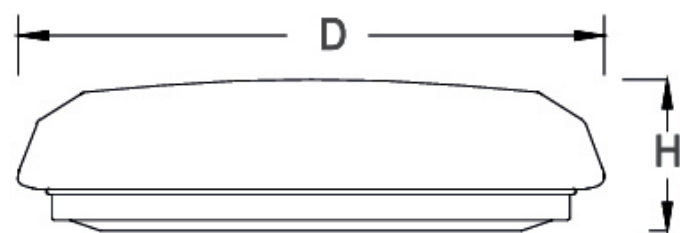

Model No. 型号	Material 材质	Input Voltage(V) 输入电压	Frequency (Hz) 频率	CCT(K) 色温	Lm/W 光效	System Power(W). 整灯功率	Operating temp range. (°C) 可操作温度范围	Product Size(mm) 产品尺寸	Carton Size(mm) 外箱尺寸	Qty/ CTN(pcs) 数量 / 箱
ZNXD 0300P	PMMA+ iron(pp)	100-240VAC	50/60HZ	3000K-6500K	100-150	12/15	-30 ~ +40	Φ300x76	495x315x320	6
ZNXD 0350P	PMMA+ iron(pp)	100-240VAC	50/60HZ	3000K-6500K	100-150	18/24	-30 ~ +40	Φ350x86	555x365x370	6

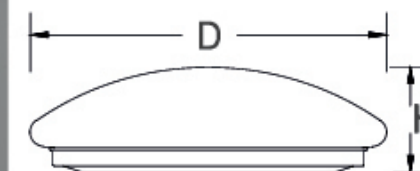

Model No. 型号	Material 材质	Input Voltage(V) 输入电压	Frequency (Hz) 频率	CCT(K) 色温	Lm/W 光效	System Power(W). 整灯功率	Operating temp range. (°C) 可操作温度范围	Product Size(mm) 产品尺寸	Carton Size(mm) 外箱尺寸	Qty/ CTN(pcs) 数量 / 箱
ZNXD0300J	PMMA+ iron(pp)	100-240VAC	50/60HZ	3000K-6500K	100-150	12/15	-30 ~ +40	Φ300x95	680x330x335	6
ZNXD0350J	PMMA+ iron(pp)	100-240VAC	50/60HZ	3000K-6500K	100-150	18/24	-30 ~ +40	Φ350x110	770x380x385	6

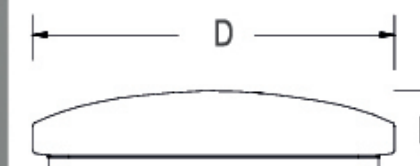

Model No. 型号	Material 材质	Input Voltage(V) 输入电压	Frequency (Hz) 频率	CCT(K) 色温	Lm/W 光效	System Power(W). 整灯功率	Operating temp range. (°C) 可操作温度范围	Product Size(mm) 产品尺寸	Carton Size(mm) 外箱尺寸	Qty/ CTN(pcs) 数量 / 箱
ZNXD0300Q	PMMA+ iron(pp)	100-240VAC	50/60HZ	3000K-6500K	100-150	12/15	-30 ~ +40	Φ300x57	560x330x335	8
ZNXD0350Q	PMMA+ iron(pp)	100-240VAC	50/60HZ	3000K-6500K	100-150	18/24	-30 ~ +40	Φ350x62	600x380x385	8
ZNXD0420Q	PMMA+ iron(pp)	100-240VAC	50/60HZ	3000K-6500K	100-150	24/28	-30 ~ +40	Φ420x67	640x450x455	8
ZNXD0580Q	PMMA+ iron(pp)	100-240VAC	50/60HZ	3000K-6500K	100-150	36/42	-30 ~ +40	Φ580x72	680x610x615	8

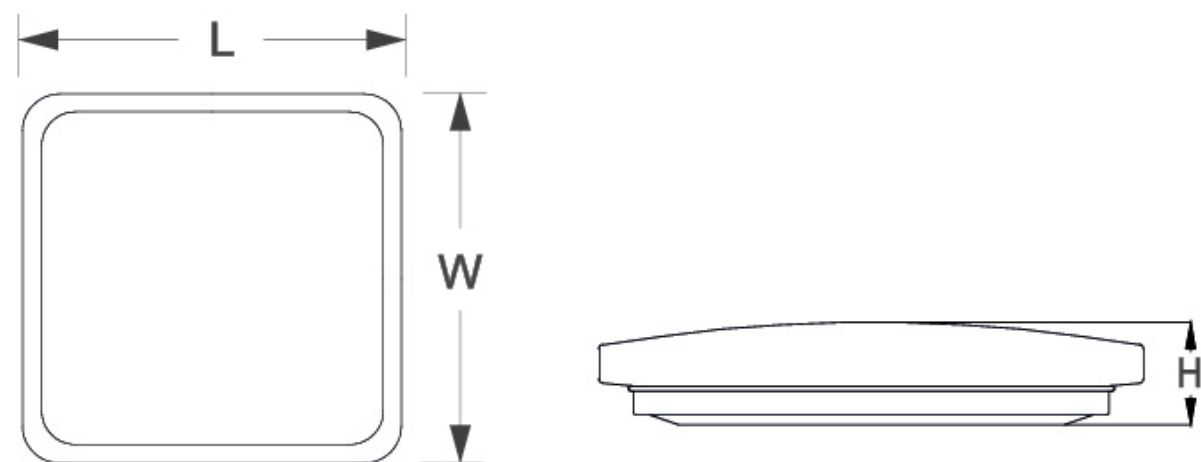

Model No. 型号	Material 材质	Input Voltage(V) 输入电压	Frequency (Hz) 频率	CCT(K) 色温	Lm/W 光效	System Power(W). 整灯功率	Operating temp range. (° C) 可操作温度范围	Product Size(mm) 产品尺寸	Carton Size(mm) 外箱尺寸	Qty/CTN (pcs) 数量 / 箱
ZNXD0385R	PMMA+iron(pp)	100-240VAC	50/60HZ	3000K-6500K	100-150	18/24	-30 ~ +40	385x385x76	655x420x425	8
ZNXD0440R	PMMA+iron(pp)	100-240VAC	50/60HZ	3000K-6500K	100-150	24/28	-30 ~ +40	440x440x86	735x480x485	8

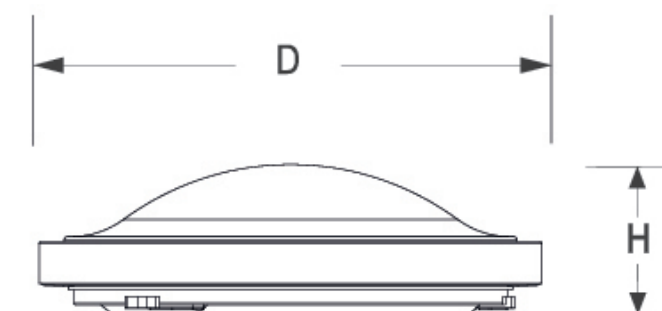

Model No. 型号	Material 材质	Input Voltage(V) 输入电压	Frequency (Hz) 频率	CCT(K) 色温	Lm/W 光效	System Power(W). 整灯功率	Operating temp range. (° C) 可操作温度范围	Product Size(mm) 产品尺寸	Carton Size(mm) 外箱尺寸	Qty/ CTN(pcs) 数量 / 箱
ZNXD0300T	PMMA+iron(pp)	100-240VAC	50/60HZ	3000K-6500K	100-150	15	-30 ~ +40	Φ300x86	555x315x320	6
ZNXD0410T	PMMA+iron(pp)	100-240VAC	50/60HZ	3000K-6500K	100-150	24	-30 ~ +40	Φ410x112	710x425x430	6

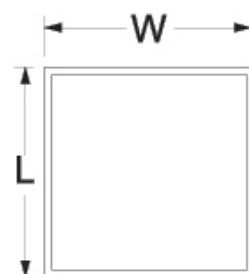
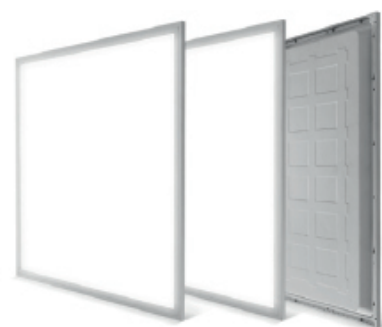

- 1: Vertical front glow
- 2: Uniform luminescence, no dark area
- 3: Non-flicker, better protect your eyes
- 4: Simple and convenient installation, saving time and cost.
- 5: Suitable for office, classroom, shopping mall, home and other places

Model No. 型号	Material 材质	Input Voltage(V) 输入电压	Frequency (Hz) 频率	CCT(K) 色温	Lm/W 光效	System Power(W) 整灯功率	Operating temp range. (° C) 可操作温度范围	Product Size(mm) 产品尺寸	Carton Size(mm) 外箱尺寸	Qty/ CTN(pcs) 数量 / 箱
ZNMB 03030	PMMA +iron	100-240VAC	50/60HZ	3000K -6500K	100-150	12	-30 ~ +40	300x300x33	390x315x320	10
ZNMB 06030	PMMA +iron	100-240VAC	50/60HZ	3000K -6500K	100-150	12/18	-30 ~ +40	600x300x33	620x230x320	6
ZNMB 06060	PMMA +iron	100-240VAC	50/60HZ	3000K -6500K	100-150	36/48	-30 ~ +40	600x600x33	620x230x620	6
ZNMB 12030	PMMA +iron	100-240VAC	50/60HZ	3000K -6500K	100-150	36/48	-30 ~ +40	1200x300x33	1220x230x320	6



- 1: Aluminum shell, good heat dissipation
- 2: Up to 150 lm/w, high light efficiency
- 3: When taking photos, Non-flicker
- 4: 5 years warranty, quality assurance
- 5: Suitable for industrial lighting, high altitude lighting, such as logistics and warehousing, etc.

Model No. 型号	Material 材质	Input Voltage(V) 输入电压	Frequency (Hz) 频率	Beam Angel(°) 发光角度	Lm/W 光效	System Power(W) 整灯功率	Operating temp range. (° C) 可操作温度范围	Product Size(mm) 产品尺寸	Carton Size(mm) 外箱尺寸	Qty/ CTN(pcs) 数量 / 箱
ZNGK110	Aluminum	220-240VAC	50/60HZ	60/90/120	130-150	110	-30 ~ +40	Φ320x100	335x120	1
ZNGK150	Aluminum	220-240VAC	50/60HZ	60/90/120	130-150	150	-30 ~ +40	Φ360x100	375x120	1
ZNGK200	Aluminum	220-240VAC	50/60HZ	60/90/120	130-150	200	-30 ~ +40	Φ400x100	415x120	1